



PFY-A10S
PFY-A10W

For household use

Electric Kettle

User Manual

Thank you for purchasing this product.
Read all the information in this user manual before using the appliance.
Keep this manual in a handy location for future reference.

家庭用

電氣快煮壺

使用說明書

感謝您購買本公司產品。請你在使用前，務必詳讀使用說明書，
以便正確使用。並請妥善保管本說明書。



English

Contents

1 Safety Instructions	3
2 Parts	7
When using the product for the first time or after the product has been stored for a while	8
3 Boiling water and dispensing hot water	9
4 Discard the hot water when it is not going to be used.	11
5 Cleaning	12
6 Troubleshooting	14
Purchasing consumables and optional accessories	15
Specifications	16

中文

目錄

1 安全上的注意事項	17
2 各部位名稱	21
第一次使用本產品或暫時沒有使用時.....	22
3 煮水及注水	23
4 不使用時請將熱水倒掉	25
5 保養方法	26
6 以為故障時	28
關於消耗品・耗材洽購	29
規格.....	30

IMPORTANT SAFEGUARDS

When using electrical appliances, basic safety precautions should always be followed including the following:

1. Read all instructions.
2. Do not touch hot surfaces. Use handles or knobs.
3. To protect against electrical shock, do not immerse cord, plugs or in water or other liquid.
4. Close supervision is necessary when any appliance is used by or near children.
5. Unplug from outlet when not in use and before cleaning. Allow to cool before putting on or taking off parts.
6. Do not operate any appliance with a damaged cord or plug or after the appliance malfunctions or has been damaged in any manner. Return appliance to the nearest authorized service facility for examination, repair, or adjustment.
7. The use of accessory attachments not recommended by the appliance manufacturer may cause injuries.
8. Do not use outdoors.
9. Do not let cord hang over edge of table or counter, or touch hot surfaces.
10. Do not place the electric kettle on or near a hot gas or electric burner, or in a heated oven.
11. Extreme caution must be used when moving an appliance containing hot oil or other hot liquids.
12. Do not use the electric kettle for other than intended use.

SAVE THESE INSTRUCTIONS

Servicing should be performed by an authorized service representative.
This electric kettle is intended for household use.

A short power supply cord is provided to reduce the risk of becoming entangled in or tripping over a longer cord. Longer detachable power supply cords or extension cords are available and may be used if care is exercised in their use. If longer detachable power supply cords or extension cords are to be used: (1) the marked electrical rating of the extension cord should be at least as great as the electrical rating of the appliance; (2) if the appliance is of the grounded type, the extension cord should be a grounding-type 3-wire cord; and (3) the cord should be arranged so that it will not drape over the countertop or tabletop where it can be pulled down by children or tripped over accidentally.



The appliance is not intended for use by young children or disabled persons without supervision. Ensure that young children do not play with the electric kettle.

1 Safety Instructions

Read carefully before using and be sure to follow the instructions.

- * The precautions described below are intended to protect the user and other individuals from physical harm and to safeguard against damage to property.
Be sure to follow the instructions since they are important safeguards.
- * Do not remove the safety instructions seal attached to the product.

Safety instructions are classified and described as shown below, according to the level of harm and damage caused by improper use of ignoring instructions.

	This indicates "There is a possibility of death or serious injury" ¹ when an improper handling of the unit is taken by the user.
Warning	
	This indicates "There is a possibility of injury" ² or damage to property" ³ when the unit is improperly handled by the user.
Caution	
<p>*1: "Serious injury" is defined here as a medical condition such as loss of sight, injuries, burns (high-temperature or low-temperature burns), electric shocks, broken bones or poisoning which will have after-effects and/or which will require hospitalization or long-term outpatient care.</p> <p>*2: "Injury" is defined here as a physical injury, a scald or an electric shock which will not require hospital treatment or long-term outpatient care.</p> <p>*3: "Damage to property" is defined here as damage extending to buildings, household effects, domestic animals, pets, etc.</p>	

Description of symbols used



The  symbol indicates a warning or caution. The specific details of the warning or caution are indicated inside the symbol or in a picture or text near the symbol.



The  symbol indicates an action which is prohibited. The specific details of prohibited matters are indicated inside the symbol or in a picture or text near the symbol.



The  symbol indicates an action or instruction to be taken. The specific details of instructed matters are indicated inside the symbol or in a picture or text near the symbol.

Extra attention must be paid when used in a household where infants or toddlers are present.



Warning



Do not allow infants or toddlers to lick the area where the power plate is connected.

Extra attention must be paid to avoid electric shock or injuries.



Do not allow children to use the appliance by themselves, and do not use in areas within the reach of infants or toddlers, this is to avoid scalds, electric shock, or injuries.



This appliance is not intended for use by persons (including children) with physical difficulties or lack of experience and knowledge - unless they have been given supervision or instruction concerning to the use of the appliance by a person responsible for his/her safety.



Attach the lid tightly until a "clicking" sound is heard.

Failure to do so may inhibit boiling or cause scalds if the electric kettle were to fall or spill hot water.



Do not touch!

Do not touch or allow your face or other parts of your body to get close to the steam vent or spout.

Especially keep out of the reach of infants and toddlers.



Caution



Do not use on an unstable surface, especially on a table or rug that is vulnerable to heat.

Failure to do so may cause a fire, or scalds if the electric kettle falls and spills hot water, or a color change/deformation on the table or rug.



Warning



Disassembly is prohibited.

Do not modify.

Do not allow anyone other than a repair technician to disassemble or repair the appliance; this is to avoid fire, electric shock, or injuries.



Use the product at local Voltage only.

Using the product at any other voltage may result in fire or electric shock.



Use an AC outlet of 7A or higher exclusively for the product.

Connecting other instruments with the same AC outlet may cause the branch socket to overheat, resulting in fire.



Do not use a damaged power cord, and do not damage the power cord.

(Protect the power cord, do not use force, place near a high humidity area, pull, twist, bundle, place something heavy on top, or tuck.) Failure to do so may cause fire or electric shock.

If the power cord has been damaged, purchase a new one from the Tiger product retailer where you purchased the product.



If dust collects on the outlet, completely wipe off the dust, this is to avoid fire.



Firmly insert the plug into the outlet to avoid electric shock, shorting, smoke, or fire.



Do not use the product if the power cord or plug is damaged or the plug in the outlet is loose, this is to avoid electric shock, shorting, or fire.



No wet hand

Do not plug in or unplug with wet hands, this is to avoid electric shock or injury.



Do not exceed the full water level mark, this is to avoid scalds due to hot water spillage.

Do not exceed the full water level mark; this is to avoid scalds due to hot water spillage.



Do not attach the lid too forcefully. Do not open or close the lid for a few moments after the water has boiled.

This may cause scalds due to the steam.



Do not place the product on a gas flame or use it with an electrical heater, induction heating cooker, microwave oven or other such appliances; this is to avoid fire, discoloration due to exposure to heat, deformation, or malfunction.



Do not insert pins, wires or other metal objects (foreign objects) into the areas where the main unit and power plate are connected. Do not allow dust or dirt to adhere to these areas.

This may cause electric shocks, shorting or fire.



Do not block the steam vent with a cleaning cloth or other items, this is to avoid scalds due to hot water spillage or deformation of the lid.



Do not boil anything other than water.

Pouring tea, milk, sake, tea bags, tea leaves, or instant food into the electric kettle may form bubbles and cause scalds due to hot liquid spillage. This may also cause scalds, corrosion, malfunction, or peeling of the fluoropolymer-coated surface.



Do not use as an ice cooler.

Cold water or ice may cause dew condensation, electric shock, or other problems.



Do not hold the main unit in your arms close to your body, tilt or rock it, shake it up and down vigorously or jolt it.

Do not tilt or tip even if it is "locked," this is to avoid scalds due to hot water spillage.



Do not tip over the product.

Do not tilt or tip even if it is "locked," this is to avoid scalds due to hot water spillage.



Do not drop or jolt the power plate; this is to avoid overheating, problems in operation or electric shocks.

1 Safety Instructions



Warning



No wetting!

Do not soak the electric kettle in water or pour water on it; this is to avoid electric shock, shorting, or fire.



Replace the lid gasket when it has turned white.

Otherwise, if the product is tipped over, hot water will pour out, possibly scalding you.



Stop using the electric kettle immediately in the event of trouble.

Continued use in anything but proper working order may result in fire, electrical shock or injury.

(Examples of trouble)

- The power cord and plug become abnormally hot.
- When the power cord is moved, power is supplied at some moments and not supplied at other moments.
- When the product is different than usual, such as it becomes abnormally hot or there is the smell of something burning.
- Water leaks from the main unit.
- Other troubles

Immediately unplug the power cord from its outlet and contact the place of purchase for inspection and servicing.



Caution



Remove the power plug.

Leave unplugged when not in use, this is to avoid injury, scalds, electric shock, or fire caused by a short-circuit.



Be sure to firmly hold the plug when removing from an outlet, this is to avoid electric shock, shorting, or fire.



Do not use a power plate other than the designated plate for this product. Do not use the power plate for any other appliances.

Do not use a power cord from another appliance, this is to avoid problems or fire.



Do not use multiple outlet receptacles, this is to avoid fire.



Do not use or place in areas prone to getting wet and do not allow the bottom of the main unit to get wet, this is to avoid shorting, electric shock, or malfunction.



Do not fill the water directly from the faucet or wet the bottom of the product.

Water may get into the product and cause shorting, electric shock, or malfunction.



Do not use near the wall or furniture.

Steam or heat may damage the walls or furniture and cause discoloration or deformation.

If using a kitchen storage rack, be sure that the steam does not stay inside.



Do not touch!

Keep a distance from the steam or condensation when removing the lid; this is to avoid scalds.



Do not dispense hot water while the water is being boiled.

Hot water may splash and cause scalds.



Do not move the main unit while the water is being boiled.

Hot water may spill out or steam may cause scalds.



Do not touch!

Do not touch the hot surface while in use or after use to avoid scalds. Be aware that the main unit will be hot immediately after boiling.



Do not touch!

When carrying the main unit, do not touch the close/open lever or the lid.

The lid may come off, and cause injuries or scalds.



Caution



Cleaning can only be done after the main unit has cooled down, this is to avoid scalds caused by touching a hot surface.



Do not wash the entire product, as shorting, electric shock or malfunction may occur.



When cleaning, unplug the AC power cord from the AC outlet first, and then unplug the main unit from the power plate. When using the product again after cleaning, make sure that the power plug at the end of the power cord, connecting area of the main unit and the power plate are sufficiently dry before connecting each part.

Otherwise, it may cause shorting, electric shock or fire.



Do not place the main unit upside down, this is to avoid malfunction.



When discarding remaining hot water, be sure to discard in the direction shown in the following illustration.

If the water is discarded from another location, the hot water may get inside the main unit and cause malfunction or scalds.



This appliance is intended to be used in household and similar applications such as:

- staff kitchen areas in shops, offices and other working environments;
- farm houses;
- by clients in hotels, motels and other residential type environments;
- bed and breakfast type environments.

Be sure that hot water does not splash onto the power switch.

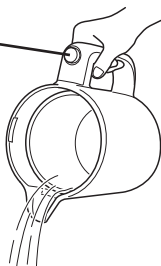

These safety instructions will allow the electric kettle to be used for many years.

- Do not use near an open flame, this is to avoid deformation or malfunction.
- Do not use in areas exposed to direct sunlight for a prolonged period. The product may become hot and malfunction.
- Do not turn on the electric kettle without water inside. Turning on the heater without water may cause heat discoloration of the interior of the container or malfunction.
- Do not put charcoal such as Bincho charcoal into the container; this is to avoid malfunction or peeling of the fluoropolymer-coated surface.

2 Parts

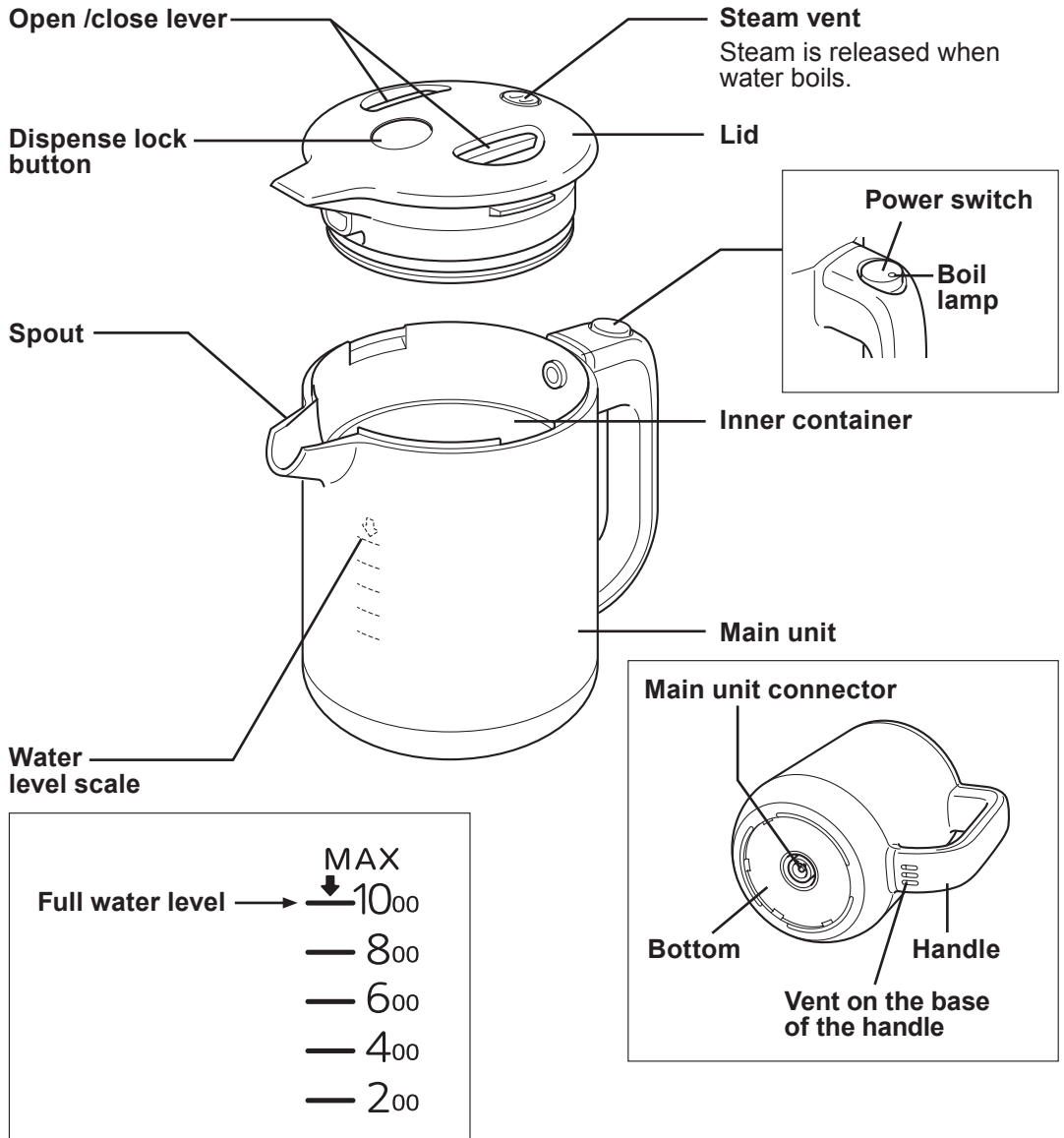

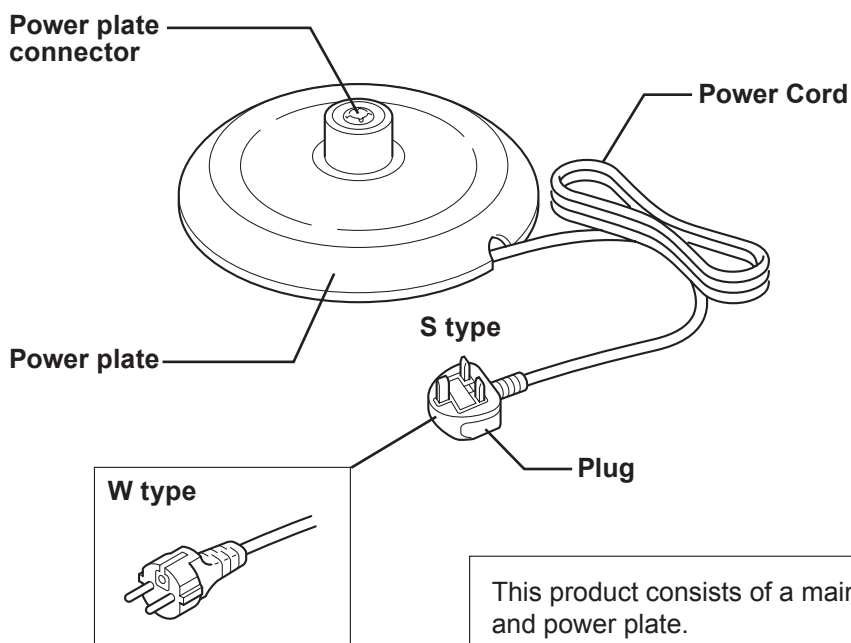

This product consists of a main unit and power plate.

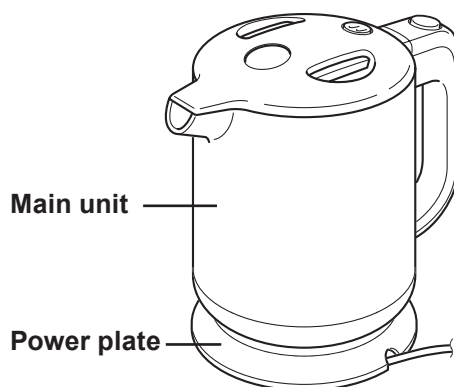

When using the product for the first time or after the product has been stored for a while

To clean the inside of the main unit, follow the steps below to boil water, and then discard the boiled water.

- 1 Fill the main unit with water to the "full water level," and boil the water. (Refer to p.9 to 10.)
- 2 Once the water has boiled, discard about half of it from the spout. (Refer to p.10.)
- 3 Remove the lid, and discard the remaining hot water. (Refer to p.11.)

3 Boiling water and dispensing hot water

1 Before placing the main unit on the power plate, remove its lid, pour water into the main unit using a separate container, and re-attach the lid.

How to remove and re-attach the lid. (Refer to p.11.)

Pour water up to a level below the “full water level.” (Refer to p.7.)

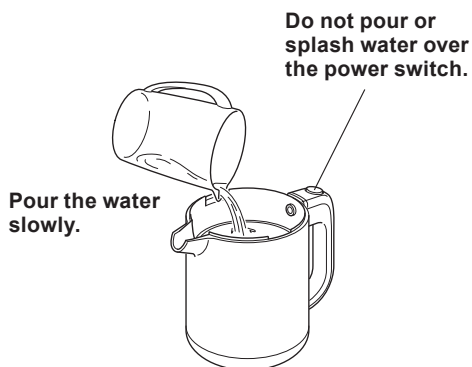

2 Lead out the power cord from the cutout in the power plate, place the power plate on a flat surface, and then place the main unit securely on the power plate.

Check that the power switch is set to “OFF”.

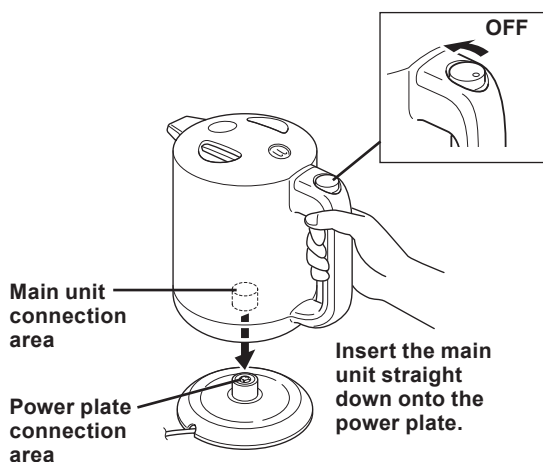

3 Check that the dispense lock button is at the “Locked” position.

If water is boiled with the dispense lock button in pressed-down position, it will take longer for the water to boil and steam may escape from the spout causing scalds.

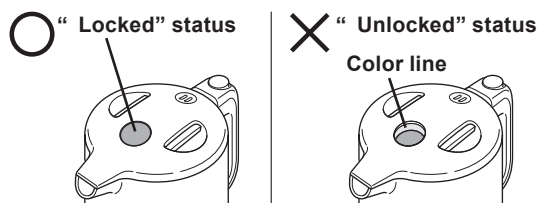

How to lock

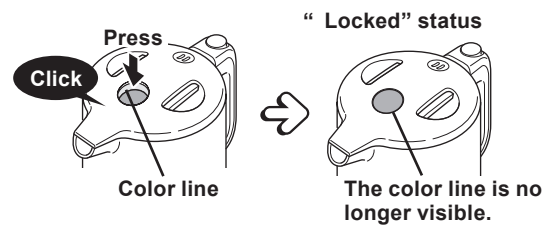

Sounds heard when dispensing the hot water or when removing or re-attaching the lid

The “rattling” sound is made by the valve (stopper valve) that prevents the hot water from spilling out in the event that the product has been tipped over.

How to adjust the length of the power cord

Adjust the length of the power cord by coiling the cord around the bottom of the power plate, and lead it out from the cutout in the power plate.

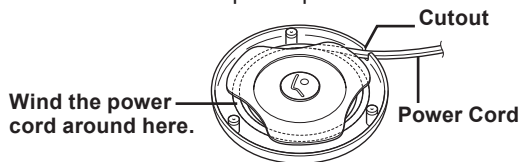

Lead the power cord out from the cutout.



Caution

- Do not fill the water directly into the product from a faucet or place the product on a wet surface so that its bottom becomes wet.
- Do not fill the water above “full water level” for boiling.
- Do not fill the water while the main unit is still in place on the power plate. Doing so may cause malfunction.

4 Connect the plug to the power outlet, and set the power switch to "ON"

[When the water is boiled]

- The power switch is automatically at the "OFF" position, and its boil lamp turns off.
- Exercise caution as steam will continue to emerge for a short while.

[When switching off the power while the water is boiling]

Set the power switch to "OFF"

This product does not keep the boiled water hot. When the water is left inside the product after boiling, it will cool off.

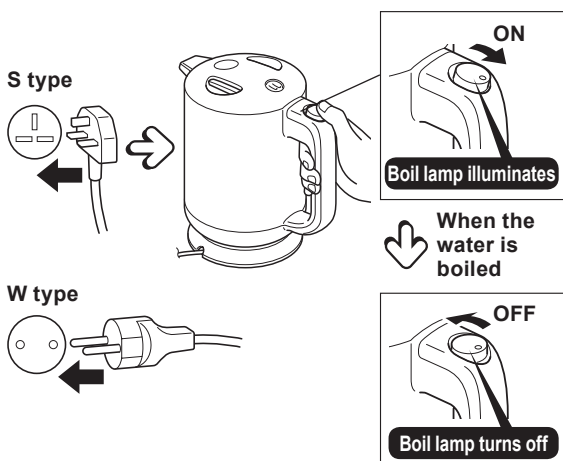

5 Check that the power switch is "OFF" and then unplug the plug from the power outlet.

Function to prevent accidental boiling without water

When boiling without water, the power switch is set to "OFF" and the boiling process is stopped. (Refer to p.14.)

Approximate times taken for boiling water

Approx. 5 minutes - 5 minutes 30 seconds

* The above times are reference values when the water temperature and room temperature are 23°C, full water volume and an AC normal rated voltage is supplied.

Caution

When the main unit is removed from the power plate while boiling, the boiling process is stopped.

6 Remove the main unit from the power plate, and press the dispense lock button to dispense the hot water.

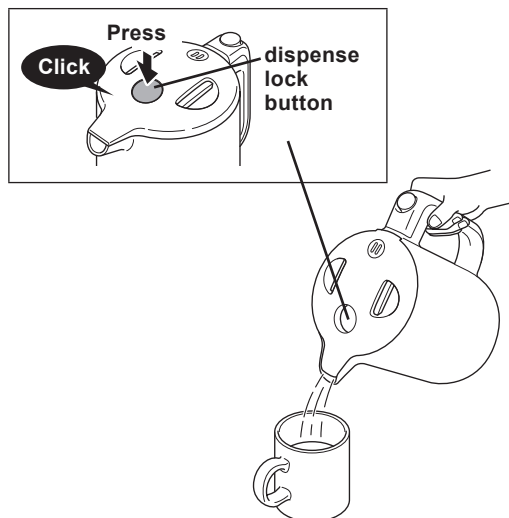

After the hot water has been dispensed, be sure to press the dispense lock button to set it to the "locked" status.

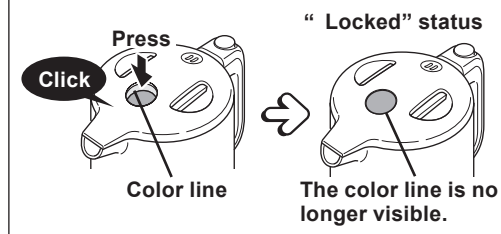

Droplets of water that drip from the vent on the base of the handle

The product is designed so that the power turns off when steam is detected. Steam may exit as water droplets from the vent on the base of the handle, but this not a malfunction.

Caution

Be sure not to touch the vent on the base of the handle when repeatedly boiling water or boiling water in a cool place, as steam or droplets of hot water may drip from this vent, and scalds may occur.

4 Discard the hot water when it is not going to be used

1 Remove the main unit from the power plate, and remove the lid

Hold the open/close levers, and remove the lid.

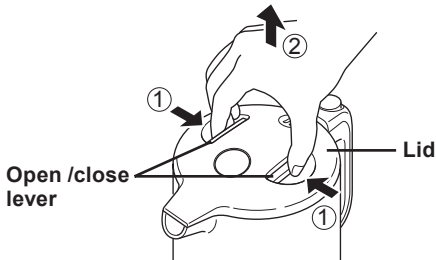

2 Discard remaining hot water

Hold the main unit by its handle, and discard hot water through the spout while taking care not to splash it. Otherwise you may be scalded.

Be sure that hot water does not splash onto the power switch.

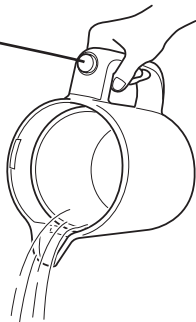

3 Attach the lid

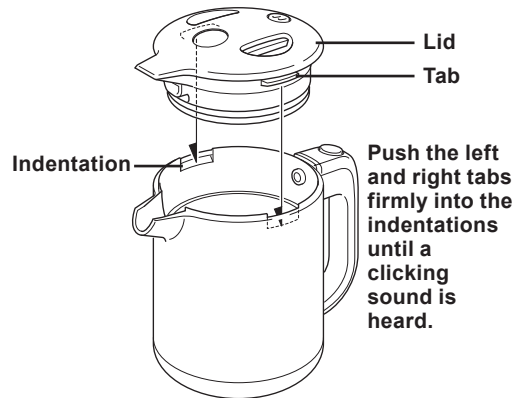

Do not leave hot water in the inner container

Discard the remaining hot water. Otherwise, the inner container may be discolored and odors may occur.

Clean the product after use

Clean the inner container frequently. (Refer to p.12.)

5 Cleaning

- ◆ Unplug the power cord and allow the product to cool down before cleaning.
- ◆ Do not soak the product in water or pour water on the product. Do not wash the entire product.
- ◆ Only use clean soft materials such as cloth, sponge or paper towel.

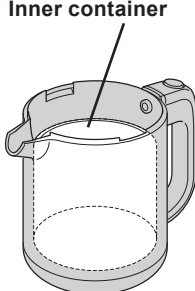
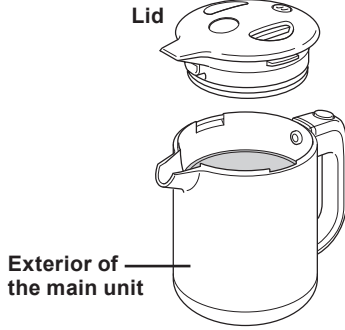
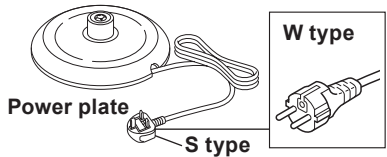
Places and parts to be cleaned frequently		<p>Pour cold or lukewarm water to fill half of the inner container, wipe the surfaces with a sponge, and then rinse. (Do not get the outside wet.)</p> <div style="border: 1px solid black; padding: 5px;"> <p>Caution</p> <ul style="list-style-type: none"> ● Do not use harmful materials such as detergent, thinner, cleanser, bleach, metal scrubber, nylon scrubber, and chemically-treated wiping cloths. ● Do not put in the dishwasher or dish dryer, this is to avoid deformation. ● The discoloration of the inner container caused by accidental boiling without water is irreversible. </div>
Places to be cleaned whenever they become dirty		<p>Wipe off stains with a damp cloth or paper towel.</p>
Places to be cleaned whenever they become dirty		<p>Wipe off with dry cloth.</p>

Concerning minerals in the water

Minerals (such as calcium, magnesium and iron) contained in the water may build up on the surfaces of the inner container and result in the situations described below. These build-ups are not harmful. When they become noticeable, clean them off using citric acid. (Refer to p.13.)

- Red rust-like spots have formed on the inner container.
- The color of the inner container has turned white, black or iridescent.
- White material is floating on the hot water.

Caution

- Clean the inner container frequently, and when the mineral deposits become noticeable, clean them off using citric acid. (Refer to p.13.)
If mineral deposits build up, it will make the hot water dispensing less smooth, and lower noises may be heard while boiling water.
- When mineral water or alkali ion water (which contains a lot of mineral components) are boiled, clean the inner container even more frequently.
The mineral deposits built up on the inside surfaces come off and clog hot water spout and steam vent inside the main unit, causing malfunction.

5 Cleaning

**If the inner container has a noticeable odor, stains or mineral buildup, clean it using citric acid.
(At a frequency of about once every 1 to 3 months)**

- 1 Put approx. 30g (2-3 tablespoons) of citric acid into the inner container.
- 2 Pour cold water up to the “full water level” and mix it with the citric acid, and attach the lid. (Do not pour hot water into the main unit.) (Refer to p.7 to 11.)
- 3 Connect the plug, boil water, and leave it for about 2 hours. (Refer to p.10.)
- 4 Unplug the plug and remove the lid, and then discard water. (Refer to p.11.)
- 5 If stains remain, scrub them off with a sponge. (In case of stubborn stains, repeat the cleaning procedure with the citric acid and water.)
- 6 In order to rinse the inner container and spout, boil only water as usual, and discard hot water with the lid still attached. (Refer to p.9. to 10.)

■ Purchasing citric acid

Citric acid can be purchased from the Tiger product retailer where you purchased the product.

Product name	Citric acid for cleaning the inner container of the electric kettle (approx. 30 g x 4 packs)
Model number	PKS-0120

* Citric acid is a food additive, and causes no harm in terms of food hygiene.

If not using for a prolonged period

- 1 Clean each part in accordance with the directions on p.12, and wipe with a dry cloth.
- 2 Dry each part. (The inner container must particularly be thoroughly dried.)
- 3 Store the product by tightly sealing it in a plastic bag, etc., so that insects, dust and other foreign objects will not get in.

6 Troubleshooting

Check the following before asking for a repair.

When	Check	Action	Reference page	
When boiling water	Is the power cord connected?	Connect the power plug.	10	
	Is the main unit positioned properly on the power plate?	Position it properly.	9	
	Is the power switch at the "OFF" position?	Set the power switch to the "ON" position.	10	
	Are there any metal fragments or dirt on the top surface of the power plate or in the connecting area of the power plate?	Unplug the plug, and then remove the metal fragments or dirt.	4	
	Is the power switch set to "ON" while there is no water inside the main unit? When the function to prevent accidental boiling without water in the main unit is performed, the power switch is set to "OFF".	Remove the main unit from the power plate, wait for the inner container to cool off sufficiently, pour in some water, attach the lid, and start the boiling process.	10	
	Hot water comes out from the spout and steam vent of its own accord.	Is water poured into the main unit above the "full water level"?	Reduce the water below the "full water level".	7•8•9
	A "bubbling" sound is heard.	The "bubbling" sound is generated by the bursting of air bubbles while boiling water.		
The "bubbling" sound seems to be louder than usual.	The sound becomes louder especially when the inner container is dirty.	Clean the inner container using citric acid.	13	
The water keeps on boiling.	Is the dispense lock button in the pressed-down position?	Set the dispense lock button to the "locked" status.	9	
The hot water has an odor	Depending on the amount of disinfectant chlorine in the tap water, the chlorine smell may remain.			
	Although resin and other materials may smell for the first several times, they become less noticeable with use.			
Problems with the main unit	The inner container is dirty. White material is floating in the hot water.	This is due to the action of the minerals contained in water: It is not the discoloration or corrosion of the inner container itself.	Clean the inner container using citric acid.	13
	Some lines and waves appear in the plastic area.	These traces occurred during molding and do not affect the proper functioning of the product.		
	Sounds are sometimes heard for some moments after use.	These sounds are heard when the heated parts are cooling down, so there are no problems with the main unit's operational quality.		
	Water droplets are dripping from the vent on the base of the handle.	The product is designed so that the power turns off when steam is detected. Steam may exit as water droplets from the vent on the base of the handle, but this not a malfunction.		

Purchasing consumables and optional accessories

These items can be purchased from the Tiger product retailer where you purchased the product.

Lid gasket (consumable)

Check the lid gasket about once a year, and replace it in the following situations. (When the product has been tipped over, water may spill out and you may possibly be scalded if you have not replaced the gasket.)

- When the color of the gasket has turned white
- When the gasket has become dirty or suffered considerable damage
- When steam has started leaking out from gaps in the lid

Part no.

PFV1007

Resin parts (when they become worn out)

The resin parts that come into contact with heat or steam may become worn out in use.

These parts are made of materials which are safe in terms of food hygiene, but replace them when they have become discolored or feel rough.

How to replace the lid gasket

How to remove the lid gasket

Remove the lid gasket.

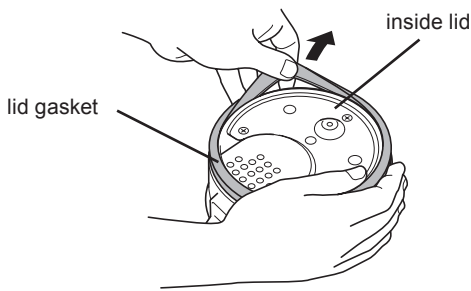

How to attach the lid gasket

Fit the new lid gasket correctly and firmly around the outer circle of the inside lid.

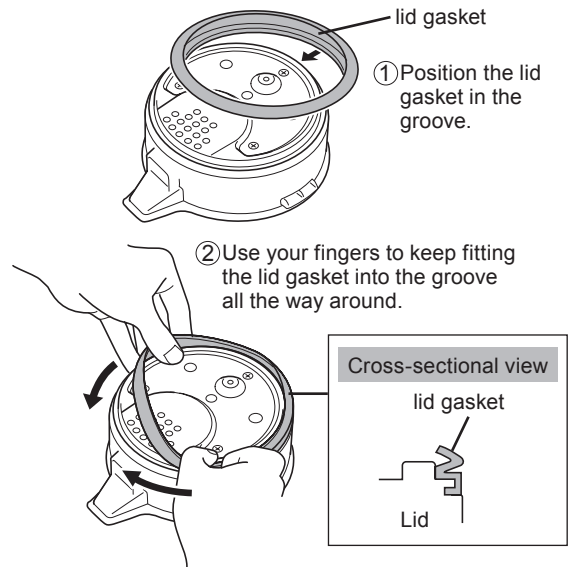

Check that the lid gasket is fitted into the groove all the way around.



Caution

- Do not remove the inside lid and other parts from the lid. This may cause steam to leak out or hot water to boil over, possibly scalding you.
- If steam continues to leak out or hot water boils over even after the lid gasket has been replaced, the other gaskets, molded parts, etc. may have been damaged. Purchase the parts from the product retailer as mentioned above.

Specifications

Rated capacity (liters)			1.0 L
Power source			S type: 220-230V / W type: 220V 50-60 Hz
Rated power consumption			S type: 1180 W-1300W / W type: 1300 W
Main unit only	Outside dimensions*1	Width	14.4 cm
		Depth	23.0 cm
		Height	21.7 cm
	Weight*1	1.0 kg	
Main unit + power plate (with main unit placed on power plate)	Outside dimensions*1	Width	14.8 cm
		Depth	23.0 cm
		Height	23.2 cm
	Weight*1	S type: 1.2 kg / W type: 1.2 kg	
Excessive temperature rise prevention device (thermal fuse)			172 °C
Length of power cord*1			0.75 m

*1: The values given are approximations.

* It may not be possible to maintain the product's prescribed performance in some areas (high altitudes, extremely cold regions, etc.).

1 安全上的注意事項

在使用前請仔細閱讀並嚴格遵守

- * 此注意項目為事前防止對使用人及他人造成危險或財產損害所標示，內容攸關於安全性的問題，請務必遵守。
- * 貼在本體上的注意貼紙請勿撕下。

以下標示是防止疏忽注意事項並將其誤用時所產生的危險與損害的程度區分。



警告

表示「誤用時可能導致使用人死亡或受傷」的內容



注意

表示「誤用時可能導致使用人受傷害或物體損害」的內容

- *1: 重傷是指失明、負傷、灼傷(高溫・低溫)、觸電、骨折、中毒等所遺留後遺症狀，以及須住院治療或須長期至醫院檢查的情況。
- *2: 傷害是指必須住院治療或須長期至醫院檢查的負傷及灼傷、觸電等情況。
- *3: 物體損害是指房屋、家產及家畜、寵物等擴大損害的情況。

記號說明



注意

△ 記號代表警告、注意。具體的注意事項會標示在記號中或在附近以圖文標註。



禁止

⊘ 記號代表此行為是禁止的。具體的禁止事項會標示在記號中或在附近以圖文標註。



指示

● 記號代表此行為請務必實行。具體的指示事項會標示在記號中或在附近以圖文標註。

有嬰幼兒的家庭在使用時請特別注意



警告



請勿讓幼兒舔食電源板通電部。
要小心勿使嬰幼兒誤舔插頭。
恐造成觸電及受傷。



上蓋左右發出「喀嚓」聲才表示已確實蓋緊。
以免萬一傾倒熱水流岀被燙傷。



不要讓小孩獨自使用或讓幼兒碰觸。
恐造成燙傷、觸電、受傷。



禁止觸碰

臉和手不要靠近蒸氣孔。
恐造成燙傷。
特別要注意不要讓嬰幼兒觸摸。



身體障礙者或未充分理解製品使用方法者，請勿單獨使用本製品。使用時，務必需要充分理解製品使用方法者在場確認。
否則，可能造成燙傷、觸電及受傷的事故。



注意



不要在不穩定的場所或不耐熱的墊子上使用。
傾倒時熱水會流出，恐造成燙傷。
另外也可能導致火災發生或是桌面、桌巾等的變色及變型。

警告



禁止分解

不要改造。
不要讓非技術人員分解或修理。

以免造成火災、觸電、受傷。



切勿使用額定電壓以外的電源。
否則會引起火災、觸電。



單獨使用規格7A以上的電源插座。

如與其他電器併用時，插座部份會異常發熱，恐引起火災。



不要使用已受損的電源線，並且不要讓電源線破損。

(加工、勉強扭曲、靠近高溫部位、硬扯、扭轉、束起、承載重物、夾住等)

恐引起火災、觸電。

電源線若損壞，請至全省虎牌服務門市洽詢維修。電源線損壞時，必須由製造商或其服務處或具有資格人員更換原廠規格以避免危險。



插頭上如有灰塵附著，要仔細清除。

以免引起火災。



插頭要緊緊插進插入口最裡面。

以免引起觸電、短路、冒煙、起火。



電源線及插頭如有損傷或插座插入鬆脫時不要使用。

以免造成觸電、短路、起火。



請勿用濕手觸碰

濕手不要拔出/插入插頭。

恐會觸電及受傷。



不要超過滿水位。

以免熱水噴出，造成燙傷。



請勿用力蓋上上蓋。沸騰後請暫時不要開合上蓋 避免因蒸氣而燙傷。



請勿使用於瓦斯爐、電磁爐、電磁調理器或微波爐。

避免造成火災、熱變色、變形及故障。



請勿在連接本體的電源板上放入迴紋針等金屬(異物)物品。

避免發生觸電、短路及火災。



不要用抹布蓋住蒸氣孔。

以免熱水噴出，造成燙傷並會造成上蓋變形。



不要煮沸水以外的物品。

如果放入茶葉、牛乳、酒、茶包或沖泡食品時，恐會產生泡泡噴出，造成燙傷。且會造成內容器燒焦、腐蝕、故障、氟素加工的剝落。



不要放入冰塊當作保冷使用。

如果放入冰水或冰塊會結露，恐造成觸電、故障。



請勿將本體傾倒或拿起來上下用力搖晃或衝擊。

即使「上鎖」也請勿傾倒。會造成熱水流出或有燙傷的危險。



請勿讓本體傾倒。

即使「上鎖」也請勿傾倒。會造成熱水流出或有燙傷的危險。



請勿讓電源板摔落地面，或衝擊。

避免發生過熱、通電異常或觸電。

1 安全上的注意事項

警告



請勿浸泡或潑水。
避免發生短路、觸電或火災。

請勿沾濕



為了避免翻倒時熱水漏出造成燙傷，若上蓋墊圈已變白色請盡快更換。



發生異常或故障時，請立即停止使用。
若繼續使用，可能會造成火災、觸電或受傷。

(異常、故障範例)

- 使用中電源線是否會異常發熱。
- 插上電源的電線是否扭曲。
- 溫度是否異常過高是否有燒焦味。
- 本體是否會漏水。
- 出現其他異常或故障。

請立刻拔下電源插頭，聯絡原購買店家進行檢查與維修。

注意



不使用時請將插頭從插座拔掉。
以免造成受傷、燙傷、因絕緣劣化而引起的觸電、漏電火災。

拔取插頭



拔下插頭時，一定要握住插頭處拔出。
以免觸電或因短路起火。



請勿使用本產品以外的電源板或使用於其他機器上。
以免造成故障、起火。



請勿一個插座插上數個插頭同時使用。
以免造成火災。



不要放置在容易被水噴到的場所使用。
底部不要弄濕。
會造成短路、觸電、故障。



請勿放在水槽中直接加水，底部請勿沾濕。
本體內部一旦進水會造成短路、觸電、故障。



不要太靠近牆壁或家具。
蒸氣或熱會使牆壁、家具損傷、變色、變形。
如果放在廚房用的收納架上使用時，要小心不要讓蒸氣籠罩在其中。



為避免燙傷，拆卸上蓋時請小心散出的蒸氣及水滴。

禁止觸碰



煮水中請勿加水。
以免熱水會飛濺，造成燙傷。



為避免熱水流出及蒸氣燙傷，煮沸中途請勿移動本體。



剛沸騰時，本體會發熱，請注意使用中及使用後暫時不要碰觸高溫部位，以免燙傷。

禁止觸碰



移動本體時，不要觸摸上蓋的開關。
為避免受傷及燙傷，請注意上蓋是否(完全)蓋緊。

禁止觸碰

⚠ 注意



清潔保養時要冷卻後再進行。
以免觸摸高溫處遭燙傷。



清潔前，請務必拔除電源插頭，並將本體從電源板上拆卸。
清潔完成後需再次使用本產品時，為避免短路及觸電、引起火災，請先確認電源插頭及本體電源通電部、電源板通電部是否充分乾燥後再各別接上。



剩餘熱水要倒掉時一定要從下圖方向倒出。
如果從其他位置傾倒，熱水會進入本體內部而造成故障，也可能被燙傷。

避免熱水潑到電源開關。

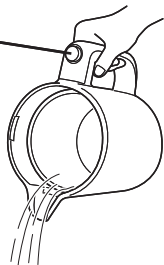

不要倒置瓶體。
若底部有水，有可能會滲入本體造成故障的原因。



請勿整支清洗。
會造成短路、觸電、故障。



本產品是一般家電，亦可於下列場所使用。

- 商店或辦公室等的專用廚房。
- 農家。
- 飯店、汽車旅館或其他住宿設施。

為能永續使用，請務必遵守

- 不要在火源附近使用
以免造成變形、故障
- 請勿放置在陽光會長時間曝曬到的地方使用
本體經常高溫時恐引起故障
- 不要空瓶煮水
瓶內沒水而通電時，會造成內容器過熱而變色、故障
- 不要放入備長炭之類的炭
以免造成故障、氟素加工剝落

2 各部位名稱

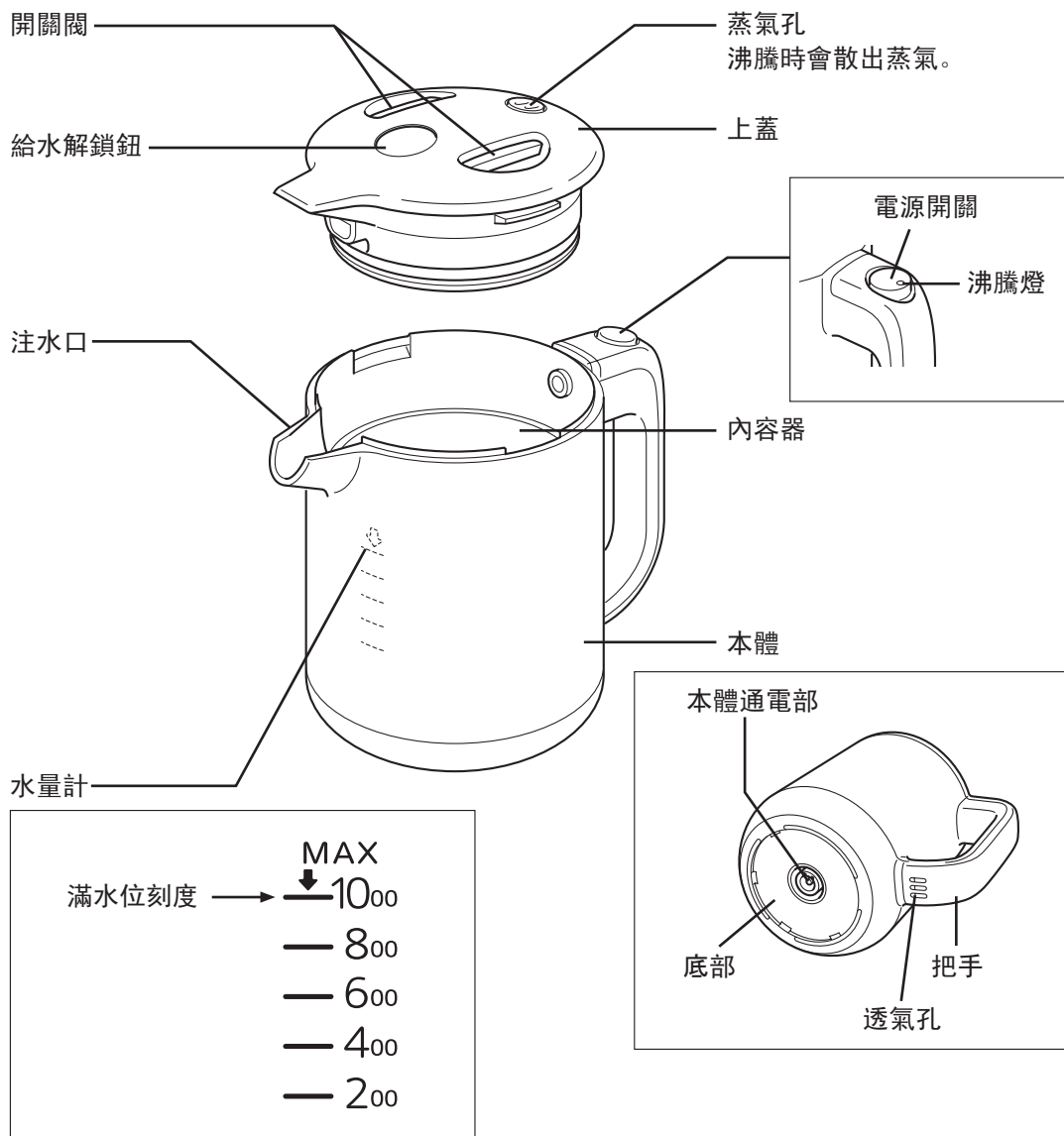

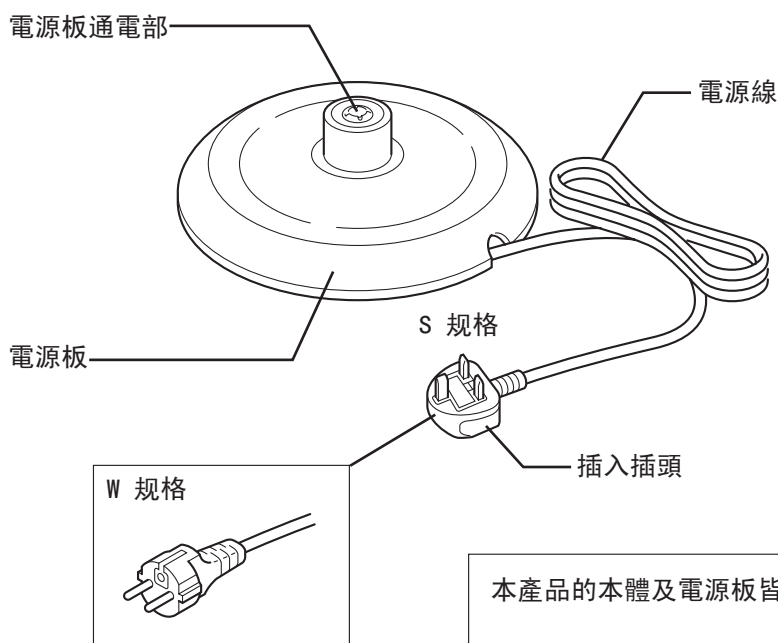

本產品的本體及電源板皆可分離。

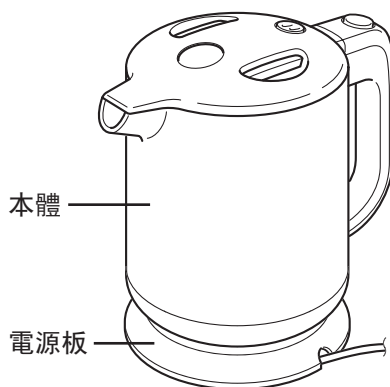

第一次使用本產品或暫時沒有使用時

清洗本體，請依照以下步驟將沸騰的熱開水倒掉。

1 請注入至滿水線，開始煮沸。→ P.23~24

2 煮沸時請從出水口倒掉約一半的熱開水。→ P.24

3 請卸下上蓋，將剩下的熱開水倒掉。→ P.25

3 煮水及注水

1 要將本體放置在電源板前，請先將上蓋拆卸並將水從其它容器中倒入，裝上上蓋。

上蓋的安裝及拆卸方式→P. 25
水請注入至「滿水線」以下。→P. 21



2 電源線請拉出至電源板缺口處，並置放於平面，再將本體確實裝到電源板上。

請確認開關是否為「關」。

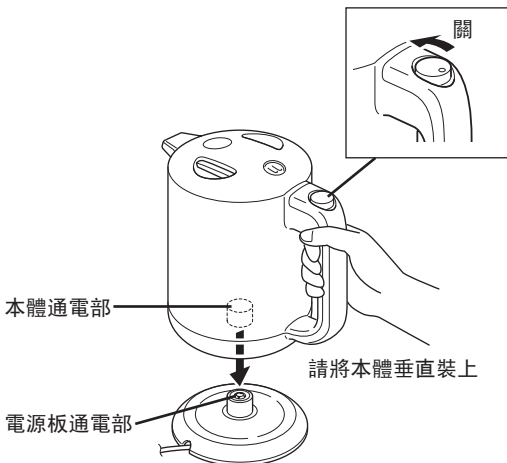

3 請確認給水解除鈕是否為「上鎖狀態」。

當給水解除鈕為押下的情況之下煮水，請注意沸騰時間將延長並蒸氣會從注水口散出造成有燙傷的危險。

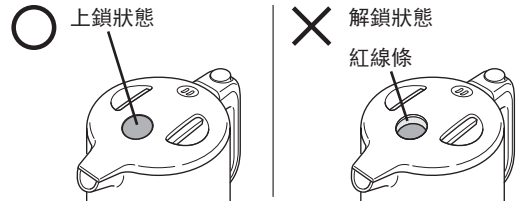

上鎖的方法

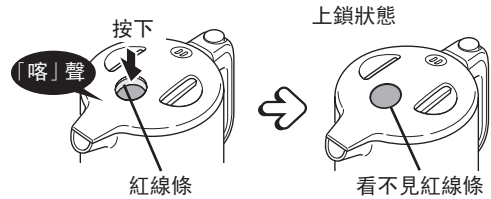

注水及拆卸上蓋時的聲音

「喀啦啦」聲為當您不小心翻倒時，防止熱水流出的防護裝置聲。

調整電源線的長度

請將電源線捲至電源板底部調整長度，再從缺口處拉出。

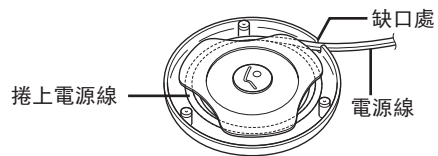

從缺口處將電源線拉出



請注意

- 請勿從水龍頭直接加水，或將本體置放在潮濕的地方。底部請勿沾濕。
- 加水請勿超出滿水線。
- 為避免造成故障，當本體置放在電源板上時請勿加水。

4 電源插頭插入電源插座後，請將電源開關切換為「開」。

[當沸騰完成時]

- 將自動切換為「關」熄燈。
- 暫時會散出蒸氣請小心。

[煮沸中途想切斷電源時]

請將電源切換為「關」。

沒有保溫功能。沸騰完成後放置時水溫會逐漸下降。

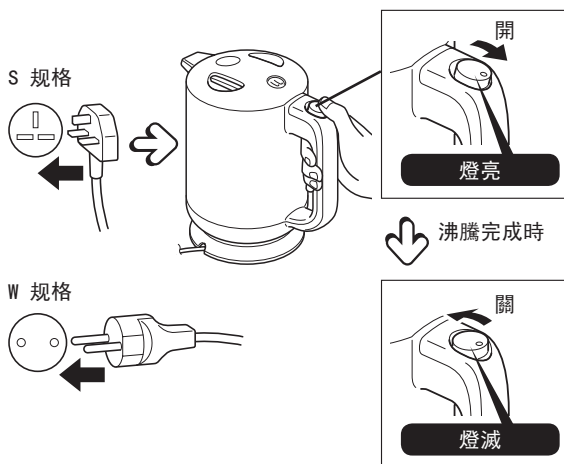

5 請先確認電源開關是否切換為「關」後，再將電源插座上的電源插頭拔除。

防空燒功能

當內容器中沒有水的情況之下煮，電源開關將切換為「關」，停止燒煮。→ P. 28

沸騰時間基準

約5分～5分30秒鐘

* 水溫・室溫：23°C，水量：滿水位，電壓：額定電壓時的參考值。

請注意

煮水途中將本體從電源板上移開，煮水將停止。

6 從電源板上拿起本體後並按下給水解除按鈕，即可注水。

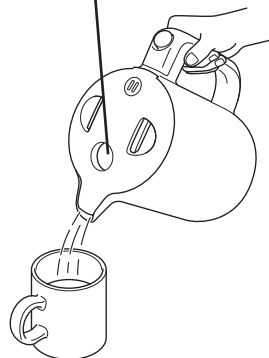
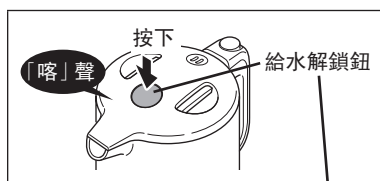

注水完後請務必將給水解除鈕再次按下，即可鎖住。

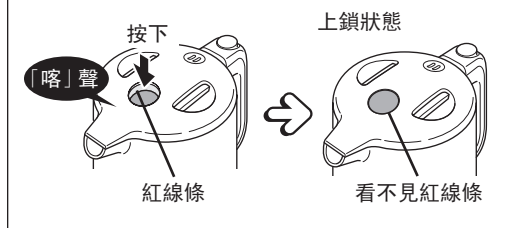

順著透氣孔流出的水滴

設有感應蒸氣後切斷電源的構造。蒸氣有時會從把手下方的透氣孔變為水滴滴下，並無故障。

請注意

連續煮水或在室溫較低的地方煮水時，蒸氣和熱水的水滴可能會從把手下方的透氣孔流出，為避免燒燙傷，請勿碰觸透氣孔。

4 不使用時請將熱水倒掉

1 從電源板上將本體拿開，拆卸上蓋。

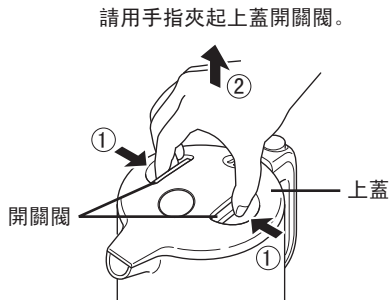

2 倒掉殘餘熱水

避免熱水潑到電源開關。

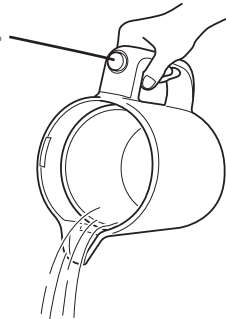

握持把手再延著注水口慢慢將熱水倒出。
請小心熱水飛濺造成的燙傷。

3 安裝上蓋

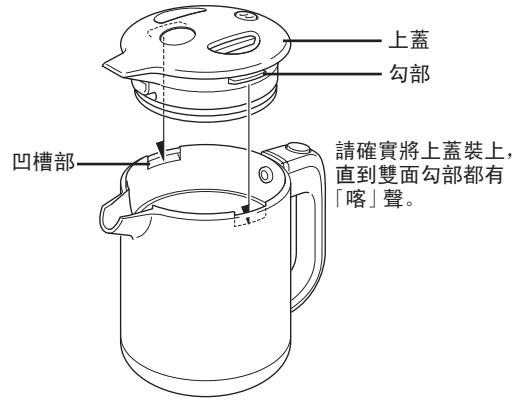

請勿在內容器中殘留熱水

會造成內容器變色或產生異味等原因，請務必將殘留的熱水倒掉。

使用後請清潔

內容器請定期清洗。→ P. 26

5 保養方法

- ◆ 拔下電源插頭，待冷卻後開始清理。
- ◆ 請勿浸水或潑水。本體請勿直接沖水清洗。
- ◆ 使用較柔軟的海棉、布等。

<p>需定期清潔的部位及零件</p>		<p>請在內容器中加入溫水至一半後，再使用海綿擦拭，清洗。 (外側請勿沾濕。)</p> <div style="border: 1px solid black; padding: 5px; margin-top: 10px;"> <p>請注意</p> <ul style="list-style-type: none"> • 請勿使用洗潔劑、稀釋劑、去污粉、漂白劑、金屬刷、尼龍刷、化學抹布等。 • 請勿使用碗盤清洗機或烘乾機，以免造成變形、故障危險。 • 因空燒所產生的內容器變色皆無法清除。 </div>
<p>當產生污垢時需清洗的部位</p>		<p>用充份擰乾的抹布擦去污垢。</p>
		<p>用乾布擦拭。</p>

關於水中礦物質成分

一般水中含有的礦物質成分(鈣・鎂・鐵分等)會附著於內容器上，此並無害。若污垢明顯時請使用檸檬酸清潔劑清洗。→ P. 27

- 內容器產生類似銹點等紅斑點。
- 內容器變色成乳白色・黑色・彩虹色等。
- 水面上有白色的漂浮物。

請注意

- 當內容器污垢明顯時，請定期使用檸檬酸清潔劑清洗。→P.27
礦物質成分累積太多，容易造成不易出水及煮水聲變大，或造成表面氯素破壞剝落。
- 使用礦泉水或鹼性水(含有非常多礦物質成分的水)煮水，請定期仔細清潔。
附著的礦物質成分容易堵塞住本體內的熱水及蒸氣出口，造成故障。

5 保養方法

內容器的異味及污垢明顯時，請使用內容器專用的檸檬酸清潔劑清洗。(約1~3個月為基準)

- ① 檸檬酸 1 包 (約 30g) 放入其它容器中用溫水化開。
- ② 請加水至滿水線，再將上蓋蓋妥。→ P.21-23
- ③ 插上電源插頭，煮沸後放置約 2 小時。→ P.24
- ④ 拔除電源插頭，拆卸上蓋後再將熱水倒掉。→ P.25
- ⑤ 污垢還殘留時，請使用海綿刷下。(污垢不易掉落時，請再次將檸檬酸清潔劑加水倒入重複上列步驟。)
- ⑥ 為了不讓清潔劑殘留在內容器及注水口，請加入清水正常煮開，最後再以不拆卸上蓋的狀態下將水從注水口倒掉。
→ P.23·24

■ 關於洽購檸檬酸清潔劑

檸檬酸粉清潔劑請至全省虎牌直營門市洽購。

品名	電氣熱水瓶內容器清潔用檸檬酸清潔劑 (約 30g×4 小包入)
型號	PKS-0120

* 檸檬酸清潔劑皆採用食品添加物，在食品衛生上為無害。

長時間不用時

- ① 按 P.26 要領保養各部位再用乾布擦拭。
- ② 讓各部位自然風乾。(特別是內容器要充份乾燥)
- ③ 為避免昆蟲及灰塵進入，請使用拉鍊袋等密封保管。

6 以為故障時

在送修前請確認。

這樣的情形時	看這裡	請這樣處理	參照頁次	
煮水時	不能煮水 (沸騰燈不亮。)	電源線是否脫落。	請接上電源插座。	24
		本體是否有正確的放在電源板上。	請正確放上。	23
		電源開關是否切換在「關」。	請將電源開關切換成「開」。	24
		電源板上及電源板通電部是否附著金屬片或異物。	請從電源插座拔除後再將金屬片或異物清除。	18
		是否在內容器中沒有水的情形之下將電源開關切換至「開」。當防止空燒功能啟動時電源開關會切換為「關」。	請先將本體從電源板上移開，等待內容器確實冷卻後再加入水並蓋上上蓋煮水。	24
	熱水會從注入口及蒸氣孔漏出。	水量是否加超過「滿水線」。	請將水量減少至「滿水線」下。	21·22·23
	有「吼—」的聲音。	「吼—」聲為當煮水中所產生的氣泡彈開的聲音。		
「吼—」聲比平常還要大聲。	內容器若有髒污，聲音會特別大聲。	請使用檸檬酸清潔劑清潔。	27	
一直沸騰。	給水解鎖鈕是否為「按下的狀態」。	請將給水解鎖鈕按回為「上鎖狀態」。	23	
有異味時	開水有味道	因自來水中所含消毒用的氯使用量不同而會殘留消毒水味。		
		剛開始使用時，有時會有樹脂等味道，隨著使用時間久後會變少。		
本體有問題	內容器髒污 熱水中有白色浮游物	為水中含的礦物質成分所造成，並非內容器本身的變色或腐蝕。	請使用檸檬酸清潔劑清潔。	27
	在樹脂部份出現線狀或波紋狀的部份	樹脂成形時產生的痕跡，不會對使用品質帶來不便。		
	暫時	為接觸到熱能後零件降溫時所產生的聲音，在使用品質上沒有問題。		
	從把手下方的透氣孔流出水滴。	設有感應蒸氣後切斷電源的構造。蒸氣有時會從把手下方的透氣孔變為水滴滴下，並無故障。		

關於消耗品・耗材洽購

請至全省虎牌直營門市洽購。

上蓋墊圈(消耗品)

請以1年為基準做確認，若出現以下情形請更換。
(翻倒時熱水漏出，有燙傷的危險)

- 變白。(裂化前現象)
- 污損明顯。
- 從上蓋的縫隙中會散出蒸氣。

零件型號	PFV1007
------	---------

樹脂零件(受損時)

會直接接觸到熱能及蒸氣的樹脂零件將隨著使用而受損。雖本產品使用食品衛生上安全的材料，但若出現變色及剝落等情形請更換耗材。

更換上蓋墊圈的方法

■ 拆卸方式

拆卸上蓋墊圈。

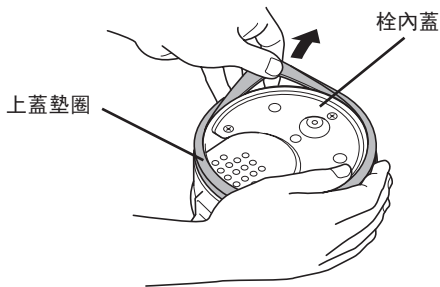

■ 安裝方式

將新的上蓋墊圈確實嵌入在栓內蓋外圍。

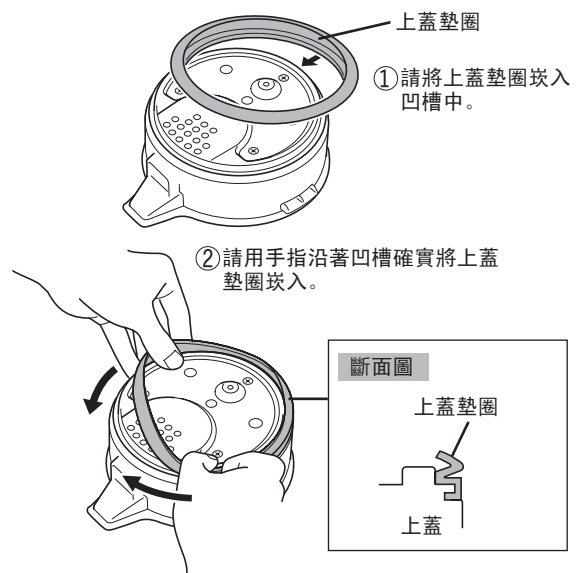

請確認是否有確實嵌入。



請注意

● 為避免蒸氣散出或熱水噴出、燙傷等危險，請勿自行拆卸上蓋中的栓內蓋等零件。

● 即使更換上蓋墊圈，仍然會出現蒸氣散出或熱水噴出等情形，有可能是其他墊圈類零件或成品已受損。請至各直營門市洽詢。

規格

額定容量			1.0 L
電源			S 規格: 220-230V / W 規格: 220V 50-60Hz
額定消耗電力			S 規格: 1180W-1300W / W 規格: 1300W
只有本體	外型尺寸 * 1	寬	14.4 cm
		深	23.0 cm
		高	21.7 cm
	重量		1.0 kg
本體+電源板 (將本體置放在電源板 上的狀態)	外型尺寸 * 1	寬	14.8 cm
		深	23.0 cm
		高	23.2 cm
	重量(含電源線)		S 規格: 1.2 kg / W 規格: 1.2 kg
溫度過高防止裝置(溫度控制器)			172 °C
電源線長度 * 1			0.75 m

*1 為大約數值。

※ 在特定地區(如高地・嚴寒地帶)恕無法確保所定的功能。



TIGER CORPORATION

Head Office: 3-1 Hayamicho, Kadoma City, Osaka 571-8571, Japan